



Coffee machines

Küppersbusch

7. EKV 6600.0 café profi coffee machine	4
7.1 Fundamental principles	4
7.1.1 Order reference for fully-automatic coffee machines	4
7.1.2 General	4
7.1.3 Structure and functioning of a fully-automatic coffee machine	5
7.1.4 Available functions	7
7.1.5 Steam appliances, semi-automatic, fully-automatic and pad machines	8
7.1.6 Keeping coffee hot	9
7.1.7 Where can I get the freshest coffee?	9
7.1.8 What is the difference between coffee and espresso?	9
7.1.9 How can I recognise a good espresso?	10
7.1.10 Initial operation	11
7.1.11 Deaerating the system	11
7.1.12 Making coffee	13
7.1.13 Adjusting filling quantities to cup sizes	13
7.1.14 Dispensing hot water	14
7.1.15 Dispensing steam	14
7.2 User settings	15
7.2.1 User settings	15
7.2.2 Grinding setting	17
7.2.3 AromaControl	18
7.3 Fittings	19
7.3.1 Flap panel (push & pull)	19
7.3.2 Water tank	21
7.3.3 Coffee bean box	21
7.3.4 Grinder	22
7.3.5 Brewing unit	22
7.3.6 AquaPrima water filter	23
7.3.7 Height and depth adjustable coffee dispenser	26
7.3.8 Two separate heating systems	26
7.3.9 Cup light-up	26
7.3.10 Accessories	27

7.4	Care and Maintenance	28
7.4.1	Water tank / bean box	28
7.4.2	Coffee dispenser	29
7.4.3	Nozzle	30
7.4.4	Drip tray / Coffee grounds container	31
7.4.5	Brewing unit	32
7.4.6	Coffee degreaser (cleaning cycle every 14 days or after 250 cups)	33
7.4.7	Descaling / automatic limescale indicator	34
7.5	Assembly / transport	38
7.6	Appendix	40
7.6.1	Carrying out minor repairs yourself	40
7.6.2	Technical data	41
7.6.3	Short lesson on coffee – coffee specialities	42

7. EKV 6600.0 café profi coffee machine

Whether as a café, espresso, late macchiato or simply with foamed milk – the type of coffee enjoyed is a matter of personal taste. It's a fact that the coffee bean brew has been the national beverage of the European population since the beginning of the 19th century. Most people nowadays associate drinking coffee with experiencing a unique flavour. The aroma and the diversity of selected coffee beans will tempt you to a completely new culture of enjoyment. The sensuous enjoyment of coffee hence expresses a personal awareness of life.

7.1 Fundamental principles

7.1.1 Order reference for fully-automatic coffee machines

The table enables you to break down the model identifier/designation and to recognise the design, the size and the features of the appliances.

For fully-automatic coffee machines this is explained on the basis of model EKV 6600.0 M.

Model identifier	Meaning	Options:
EKV		EKV = Built-in fully-automatic coffee machine
6	Appliance width	6 = 60 cm wide
600	Fittings	The figures refer to the classification of the coffee machine within the product line.
.0	Generation	Modification options
M	Design	M = Metallic (stainless steel)

The appliance identifier hence means:
the EKV 6600.0 M is a fully automatic built-in coffee machine, 60 cm wide, a generation 0 appliance in a stainless steel design.

7.1.2 General

The new Küppersbusch built-in fully automatic coffee machine makes coffee machines an integral part of kitchens and attractive eye-catchers too. No valuable worktop space is wasted. Built-in fully-automatic coffee machines offer more than extensive, convenient features. The elegant design is also a real highlight. At home, in studio kitchens, in offices and in elegant business premises.

Control unit and coffee dispenser



The smart electronic system regulates complex brewing processes and the clear optical display guides users through all of the new coffee machine programs, hence making operating and programming the machine child's play, even for inexperienced coffee makers. The various settings, such as setting the brewing temperature, pre-brewing time, volume of coffee beans to be ground and water hardness provide the new product with all that it takes to develop individual flavours. The new EKV 6600.0M coffee machine enables you to experience the special flavour of coffee specialities such as espresso, latte macchiato, cappuccino and lungo.

7.1.3 Structure and functioning of a fully-automatic coffee machine

Operating the built-in fully-automatic coffee machines is quite simple since they are operated from the front. They are ready to use in no time at all – it's all so easy. The panel opens very easily when the bar handle is pressed. The water tank which is filled from the front, the coffee bean box and the main switch are all located behind the panel.

All of the functions of the fully-automatic coffee machine can be set on the control panel. The brewing unit and the adjusting knob for the grinding setting are located behind the service flap.

The height and the general depth of the coffee dispenser can be adjusted at the bottom. The AromaControl knob is used to adjust how strong the coffee is when it is poured out. The collecting bowl collects anything that overflows or drips and is used to deposit the cups. The jet can be used for hot water, for steam to froth milk or for warming up beverages.

Overview EKV 6600.0 M

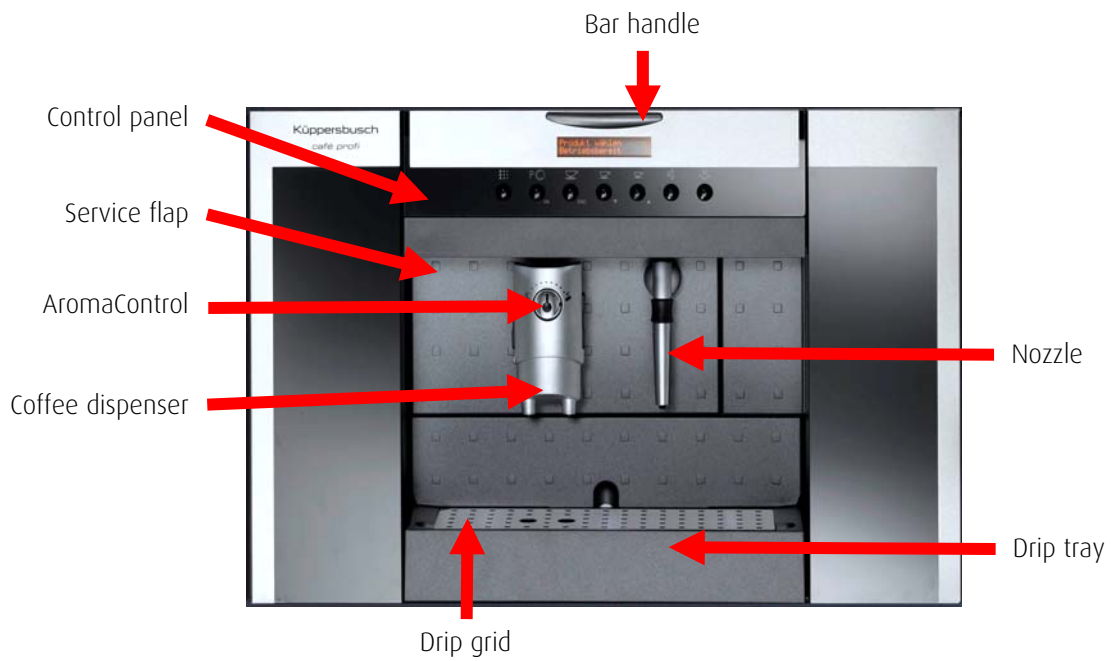

7.1.4 Available functions

The control panel is used to set a number of diverse functions.

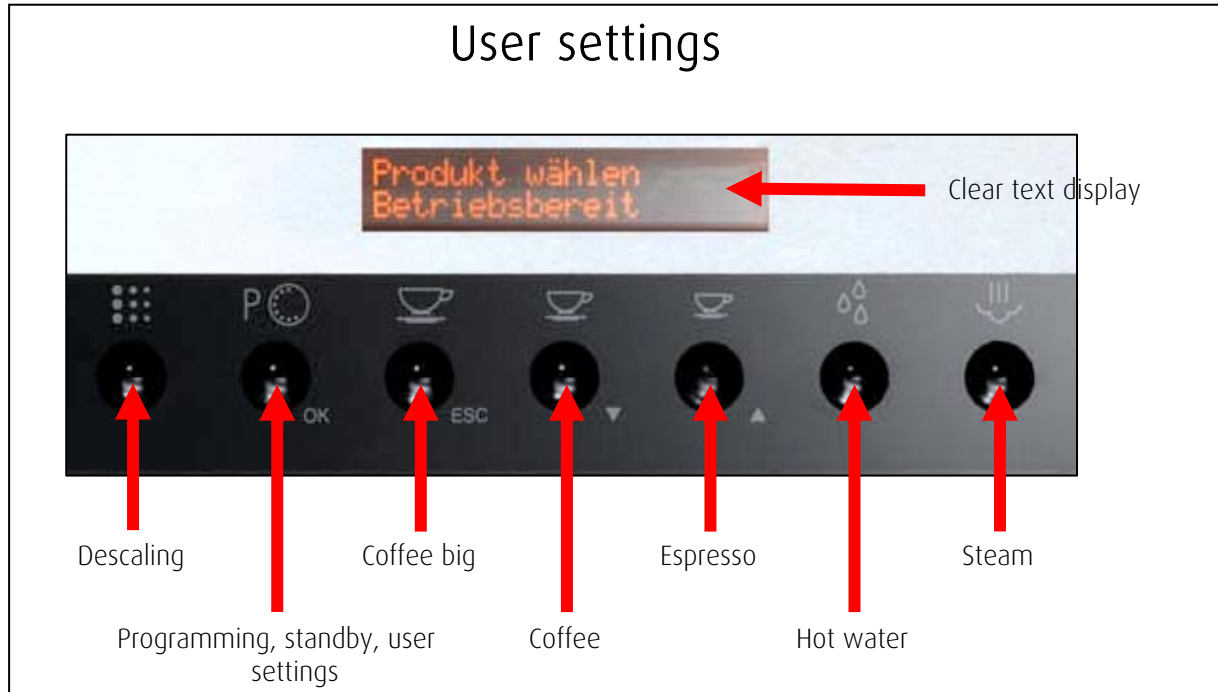

Descaling

A descaling process will be started when this button is pressed for 5 seconds (see Section 7.4.7).

Programming, standby, settings

Personal user settings can be seen in Section 7.2.1.

Long coffee – coffee - espresso

The type of coffee or espresso required is poured out when the corresponding buttons are pressed.

Hot water

The hot water dispenser is activated when the button is pressed. Pressing the button again will stop the dispensing process.

Steam

The steam dispenser is activated when the button is pressed. Pressing the button again will stop the dispensing process.

7.1.5 Steam appliances, semi-automatic, fully-automatic and pad machines

Numerous different systems for “coffee and espresso machines” are available on the market. The different methods of making coffee applied by the steam appliances and the semi-automatic, fully-automatic and pad machines are described below.

Steam appliances

Water is heated up in a water tank for this standard type of espresso machine. Pressure builds up when the water begins to boil. This pressure forces hot water through a sieve filled with espresso powder. Disadvantage: the water that makes contact with the espresso powder is very hot. This releases bitter substances into the espresso, making it bitter and unenjoyable.

Portafilters /semi-automatic machines

With so-called semi-automatic machines or portafilter appliances a lot is automated, but not everything. Espresso powder must be filled into the portafilter of the machine. Only then is the sieve put into the machine. Water is automatically portioned with a pump at a temperature of more than 98°C, heated up and forced through the espresso powder at high pressure. Semi-automatic machines need to be cleaned manually every time they are used, as oils contained in the espresso powder will otherwise be deposited in the machine. They will become rancid with time and spoil the taste of espresso.

Fully-automatic machine

Everything happens quite automatically here at the press of a button! Coffee powder is automatically ground, apportioned and filled into the sieve (brewing chamber). The hot water is then forced through the sieve and the coffee or espresso will be ready. The sieve will clean itself.

Pad machines

So-called pad machines are coffee machines that make coffee in cup-size portions. Coffee powder is put into the machine as pre-filled pads. The advantage of this type of machine: no portioning is required, since the pad that is put into the machine has already been filled with the right quantity of powder. Disadvantage: the ground coffee in the pre-filled pads loses its aroma quickly if it is stored for any length of time.

7.1.6 Keeping coffee hot

Coffee should not be kept hot on the hotplate of coffee machines or on a warmer. The reason: the heat will cause the coffee to re-draw. This means that water will evaporate, resulting in the evaporation of the fine coffee aroma. Coffee will not only lose its flavour; it will also taste bitter very quickly.

7.1.7 Where can I get the freshest coffee?

Coffee bought at the small roasteries found in almost any larger town is freshest. These roasteries generally sell high-quality beans which are roasted gently for a long time.

7.1.8 What is the difference between coffee and espresso?

Espresso and coffee are made from the same bean but the roasting times are different. Espresso is roasted for longer than coffee. The result: espresso is tastier and has a stronger coffee flavour with a lower acid content. Classic espresso generally comprises a mixture of Arabica and Robusta beans.

However, what distinguishes espresso and coffee most is the way they are made. Espresso is not made in filter paper; it is made in a metal sieve. Within 10 to 12 seconds for automatic coffee machines and within 25 to 35 seconds for espresso machines used on a cooker hotplate, water heated up to 95°C is forced through this sieve. This means that the espresso powder only makes brief contact with the hot water. All of the flavouring but only a little caffeine and few bitter substances are dissolved in the powder. This is why an espresso, which is considered to be a black, particularly strong beverage, only has half as much caffeine as a cup of coffee.

7.1.9 How can I recognise a good espresso?

Blend

Espresso experts swear by espresso blends which not only contain expensive Arabica beans, but also comprise a 20% to 30% proportion of Robusta beans. This lends espresso a full flavour and a strong aroma. The proportion of Robusta beans is also vital for the espresso crema. The high content of ethereal oils in this bean makes the crema especially tasty and creamy. When buying, consumers should make sure that the espresso has a robusta bean content of at least 20%. It will then have the typical tart flavour and a super crema. The beans can be blended in specialised retail stores according to personal preference.

Grinding setting

Espresso powder should not be too coarsely ground. The reason: the water would not make sufficient contact with the powder for the flavours and aromas to develop properly. Espresso beans ground at setting one or two are ideal.

Crema

What is also important for a good espresso is the "crema", i.e. the foam on top of espresso. It should be a hazelnut brown colour and as thick as possible. A spoon of sugar will stay on top of a good crema for two to three seconds and will only then submerge.

The crema is so important because it functions like a lid to protect the espresso. Precious aromas and flavours do not evaporate so quickly. Instead they are contained in the espresso by the crema.

Temperature

A ready-made espresso should not be served colder than 80°C, as flavours and aromas will otherwise not be able to develop their full potential. This is why connoisseurs drink their espresso quickly in two or three sips as soon as it is served. This is how to get the most out of an espresso.

7.1.10 Initial operation

Before you enjoy your first coffee, open up the control panel with the bar handle and fill up the water tank located behind it with a max. of 1.7 litres of water. The water filter enclosed may also be used. A max. of 300 g of coffee beans must then also be filled into the bean box. Switch on the appliance at the main switch and close the control panel. The clear text display will indicate "deaerate". The system must now be deaerated (see Section 7.1.11).

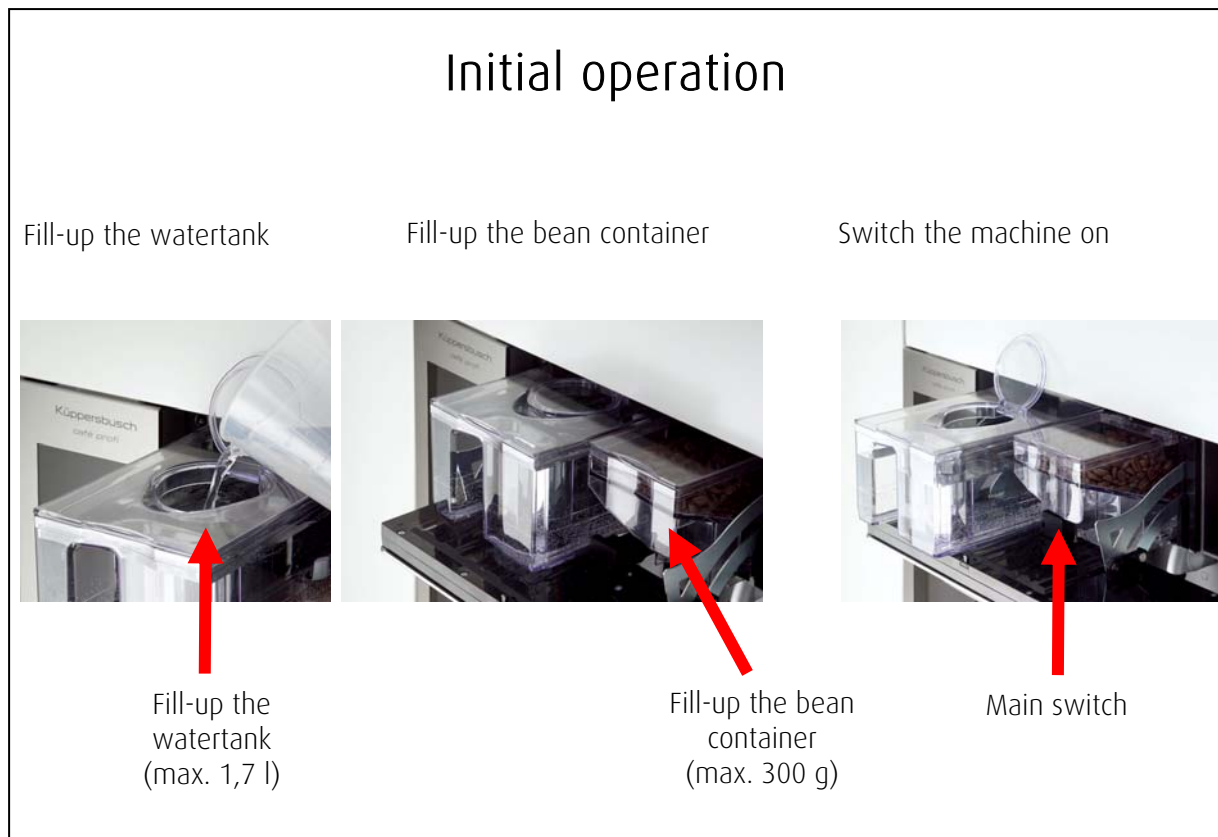

7.1.11 Deaerating the system

Place a high vessel under the nozzle. Touch the "hot water" button and allow hot water to flow until you have a regular stream of water. Touch the button again and stop the flow of hot water. The clear text display will show "select product" and "ready".

Deaerating the system



- ▶ Place a high vessel under the nozzle



- ▶ Touch  and allow hot water to flow until you have a regular stream of water



- ▶ Touch  again and stop the flow of hot water. The display will show "select product" and "ready"

7.1.12 Making coffee

If the machine is in the standby mode this will firstly need to be cancelled with the “P” button. Then place one or two cups under the coffee dispenser. Set how strong you want the coffee to be with the AromaControl knob. Touch either the “coffee long”, “coffee” or the “espresso” button. For one cup press the button once or press it twice for two cups.

Making coffee



Deactivate the standby mode by touching button “P”



Aroma Control

► The quality of the coffee can be set progressively from mild to strong



Start brewing

► Press the button of your choice (e.g. espresso)

1 cup	= 1 x
2 cups	= 2 x



Place 1 or 2 cups under the dispenser

- Cups may be pre-warmed
- Push the coffee dispenser upwards for large cups

Genuine fully-automatic two-cup coffee machine

Thanks to its professional brewing unit the built-in coffee machine is able to make two cups of coffee at once. This saves time, especially when numerous guests are being catered for.











7.1.13 Adjusting filling quantities to cup sizes

Households have different sizes of cups for coffee and for espresso. The fill-up quantity can be adjusted quickly to the respective cup size so that a cup is filled up with just the right amount. Simply place a coffee cup or an espresso cup under the coffee dispenser and press the button for espresso until the right quantity is in the cup. After this, each time the “espresso” button is pressed an espresso cup will be filled with the same quantity, until a new setting is made. This setting can naturally also be made for the “coffee long” and “coffee” buttons.

7.1.14 Dispensing hot water

Place a cup under the nozzle. Touch the “hot water” button and allow the required quantity of water to be dispensed. Touch the button again to stop the flow of hot water.

Dispensing hot water / steam

Hot water	Steam
 <p>▶ Place a cup under the nozzle</p>	 <p>▶ Place a cup under the nozzle</p>
 <p>▶ Dispense hot water; press button </p>	 <p>▶ Start steam by pressing button  and heating up the beverage with circular movements</p>
 <p>▶ When you have the right quantity press </p>	 <p>▶ When you have the right temperature press the button </p>

7.1.15 Dispensing steam

Place a full cup under the nozzle. Touch the “steam” button to start the steam dispensing mode. Heat up your beverage with circular movements or froth the milk. As soon as the required temperature has been reached touch the button again and stop the steam dispensing process.

7.2 User settings

The clear text display dialogue system makes both operating and programming the machine easy, even for those who are not familiar with it. The integrated rinsing, cleaning and descaling programs are also remarkable - all it takes is the push of a button.

7.2.1 User settings

If the need arises you may make adjustments to the settings as follows with the “P = program, standby, user settings”:

User settings



Available functions

▶ Standby	▶ Lighting	▶ Aroma Espresso	▶ Timer
▶ Rinsing	▶ Water hardness	▶ Aroma coffee	▶ Time-of-day
▶ Language	▶ Water filter	▶ Aroma coffee big	▶ Cleaning cycle
▶ Contrast	▶ Temperature	▶ Pre-brewing	▶ Factory settings
		▶ Total coffee	

Standby

The machine switches into the power-down mode (3 – 4 W).

Rinsing

The cycle is automatically cleaned when the machine is switched on. Coffee is always made with fresh water. A rinsing cycle is activated at a boiler temperature of below 40°C.

Language

Selecting a language on the clear text display. There is a choice of German, French, English, Spanish and Dutch.

Contrast

The contrast setting for the clear text display can be made in 10 stages.

Lighting

Switching the lighting on and off.

Water hardness

There are 4 settings for the water hardness.

Water filter

Water filter present (yes – no): is only set the first time the water filter is used. “Reset” will then need to be selected every time the filter is changed.

Temperature

Choosing the temperature for making coffee. There is a choice of low (88°C) – medium (90°C) – high (92°C). A cold cup will cool down coffee being poured into it by approx. 10°C. The temperature of the water used for brewing the ground coffee powder should be between 88°C and 92°C. Some of the flavouring will not be released into the powder if the water is too cold. On the other hand, if the water is too hot the coffee may taste somewhat bitter and burned.

Aroma Espresso

Choosing the quantity of ground coffee for espresso. There is a choice between mild – normal – strong.

Aroma coffee

Choosing the quantity of ground coffee for coffee. There is a choice between mild – normal – strong.

Aroma coffee long

Choosing the quantity of ground coffee for coffee long. There is a choice between mild – normal – strong.

Pre-brewing

The coffee is firstly moistened. This allows the flavour to fully develop. There is a choice between on (approx. 1.5 sec.) – off – long (approx. 4 sec.).

Total coffee

The total number of coffee portions being dispensed is shown.

Timer

This is for setting the time after which the machine is switched into the standby mode. It is pre-set at three hours.

Time-switch

The following may be selected:

Time-switch (on - off): setting whether the switch-on and switch-off times are to be activated.

Time of day: setting the current time of day:

Switching times: setting the switch-on and switch-off times.

Display time of day: activating or deactivating the time of day display.

Cleaning cycle

Setting the cleaning cycle. The cleaning cycle serves to degrease the brewing unit.

Factory settings

Re-setting all of the settings to the as-delivered state. There is a choice of no – yes.

7.2.2 Grinding setting

Setting the grinder as you wish to enable the selected coffee beans to develop their full flavour to perfection is child's play. The adjusting knob for the grinding setting is located on top of the brewing unit behind the service flap. The knob can be set from fine to course in 10 stages. When the grinding setting is adjusted no coffee beans may be present in the grinder.

Which grinding setting is best for coffee?

The quantity of coffee is important for the flavour and the aroma of coffee as well as for how the coffee agrees with you. As a matter of principle: the stronger you like your coffee, the finer it should be ground. Finely-ground coffee turns out stronger than when it is coarsely-ground. You must however be careful: if the beans are ground too finely the coffee will quickly taste too strong and too bitter. Too much flavouring and in particular too many bitter substances are released when the coffee is brewed. On the other hand, if too little powder is used, coffee will taste weak and bland.

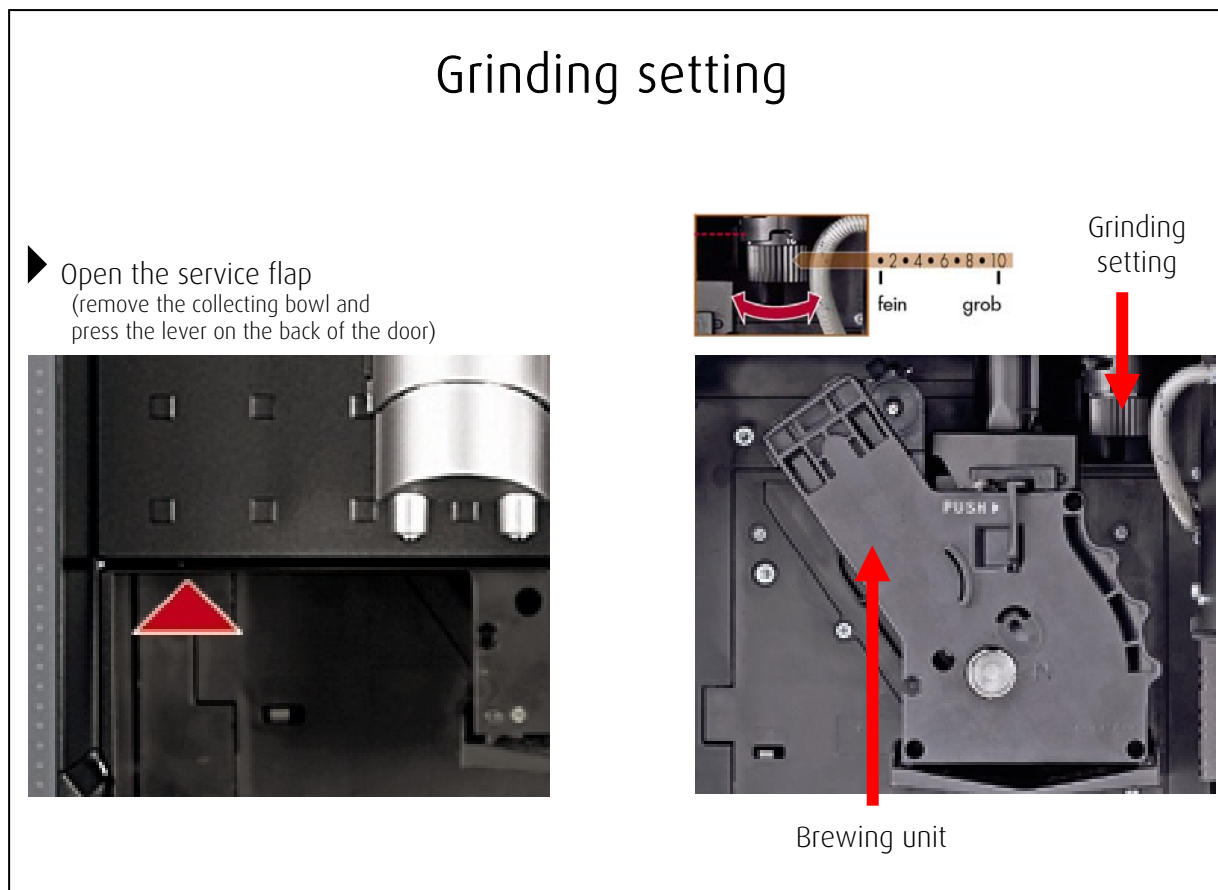

7.2.3 AromaControl

The AromaControl can be turned for a choice of flavours. Your personal taste will decide: from mild American to strong Italian coffee.

AromaControl

(Operation with standard grinder setting)



Maximum setting
for mild coffee



Type Café Crema

- Fast brewing process
- Good extraction of flavour
- Low water pressure
- Normal quantity of water

Medium setting for
normal coffee



Type Espresso

- Slow brewing process
- Optimal extraction of flavour
- High water pressure
- Low quantity of water

Minimum setting
for strong coffee



Type Ristretto

- Slow brewing process
- Optimal extraction of flavour
- High water pressure
- Low quantity of water

With the AromaControl knob which is located at the coffee dispenser, the strength of coffee can be variably-adjusted between mild coffee and strong coffee to suit any personal taste.

AromaControl

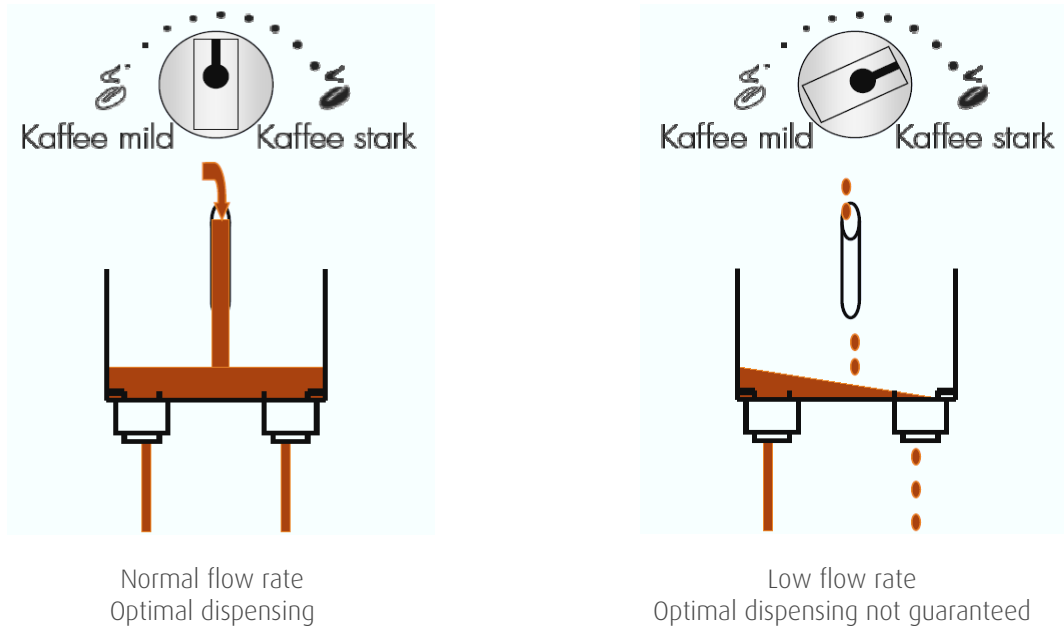

7.3 Fittings

7.3.1 Flap panel (push & pull)

The water tank and the coffee bean box, located behind the control panel, ensure that the coffee machine is extremely easy and convenient to use. A light touch will open up the push and pull panel of the coffee machine so that you can easily remove the individual filling units without having to go to the trouble of driving out the appliance unit. Filling up water and coffee beans has never been easier.

Easy-to-handle: The flap panel



- ▶ The water tank and the bean container are concealed behind a push & pull flap and can be operated from the front.



Watertank

Bean container

- ▶ The panel opens very easily when the bar handle is pressed
- ▶ Watertank and filter, 1,7 litre capacity
- ▶ Bean container for 300 g (20 – 30 cups)

7.3.2 Water tank

The fully-automatic coffee machine has an integrated water tank which holds approximately 1.7 litres of water. The tank should be filled with fresh water at least once a day, since germs may develop in water which has been left standing. The water tank can easily be removed from the front when the flap panel has been opened up and it can then be filled through an opening which is covered with a spring lid.

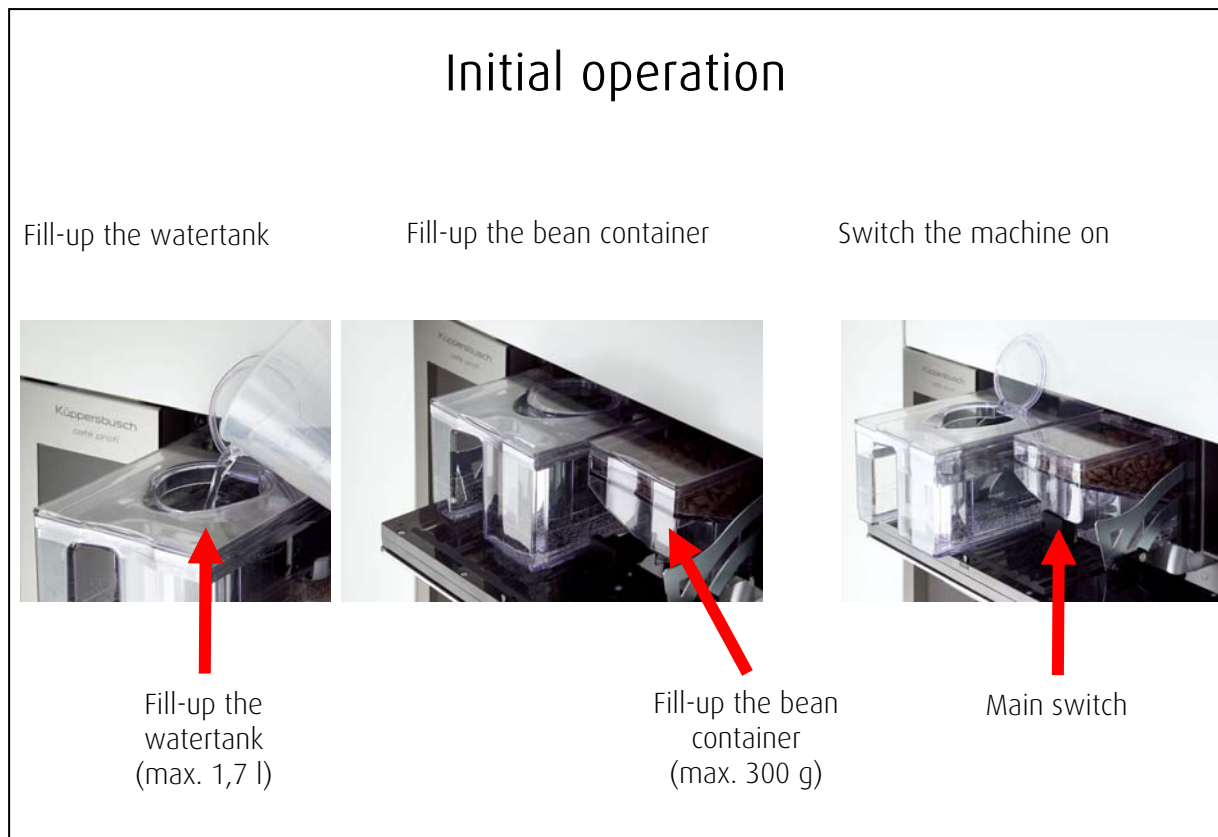

7.3.3 Coffee bean box

The fully-automatic coffee machine has an integrated bean box. The flavour-protecting lid keeps the supply of beans fresh for 1 – 2 days and the coffee aroma is not dissolved in the air. Only fresh beans are a guarantee for really fresh enjoyment. This is why beans are only ground shortly before coffee is brewed.

HINT: Whole beans or ground coffee?

You will be able to enjoy your coffee most if your coffee beans are freshly-ground shortly before you make coffee. The reason: the aroma of coffee beans is protected as long as the beans have not been ground, i.e. are whole. Grinding the beans releases the flavours and the aromas. If the beans are only ground just before the coffee is to be made, no aroma will go lost! Coffee is also most aromatic when made this way, since it is only immediately after coffee beans have been ground that they develop their flavour best.

7.3.4 Grinder

In order for selected coffee beans to develop their full flavour to perfection, they must firstly be ground to just the right fineness. The excellent quality of the innovative ceramic grinder guarantees that you will be able to enjoy perfect coffee; it is also extremely quiet in operation. The top-quality grinder material has a very long useful life span and also enables coffee to be precisely dosed, ensuring that it is consistently ground. The grinder should not be set at too fine a setting, since this will make the coffee grounds very compact and reduce the flow. If possible the grinder should not be reset – this should only be done last of all – instead it should be left at the setting of “5” made in the factory.



7.3.5 Brewing unit

The brewing unit brings out the full aroma and is the heart of all fully-automatic coffee machines. It is easy to remove and simple to clean (see illustration under section 7.2.2).

7.3.6 AquaPrima water filter

Water quality

Coffee can only taste as good as the water with which it is made. A ready-made cup of coffee comprises at least 98% of water. It is mainly the pH value and the lime content that influence the taste of coffee.

The optimal pH value for a good cup of coffee is in the neutral range of between 6.5 and 7.5. Coffee will taste bitter if the pH is higher. On the other hand, if it is lower coffee will take on a slightly tart taste.

Water hardness defines the lime content of water. It is indicated in degrees of German hardness ($^{\circ}\text{dH}$). The optimal water hardness level should be more than 7°dH to 8°dH . If the water is not hard enough the flavouring will not have sufficient aroma carriers. The result: coffee will taste bland.

Hint: If the water is too soft, i.e. if the pH level is below 6°dH , simply mix a pinch of salt with the coffee in the filter paper. This will release the flavour into the coffee without leaving a salty taste. If the water is too hard, it would be advisable to use the AquaPrima water filter. This filter optimises the pH value and the water hardness.

Using the water filter

AquaPrima water filter



▶ Open the control panel by pressing the bar handle



▶ Insert the water filter according to package insert



▶ Fill up with fresh water (max. 1.7 litres)



▶ Insert watertank

▶ The machine can be used without a water filter but will then need to be descaled more frequently. Using a water filter improves the quality of the coffee and results in less wear and tear to the components.

Operating mode

The AquaPrima water filter takes effect in a number of ways: the charcoal (activated carbon) reduces the occurrence of substances that have a detrimental effect on the smell and the taste of water. The ion exchanger resin binds heavy metals, reduces the level of limestone and removes other pollutants. A special, porous filter retains minute particles from the water. The level of water hardness is reduced by 10°dH. The AquaPrima is yielding and is sufficient for 60 litres or for approx. 750 portions of coffee. It is food-safe and environmentally-friendly. A filter is included with the machine. Replacement filters can be ordered through customer service.

AquaPrima water filter

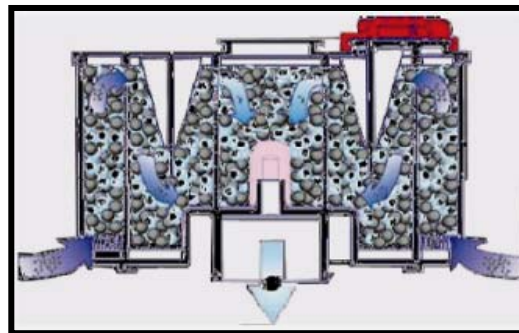

Filter structure

- Active carbon
- Ion exchanger
- Porous filter
- Filter

If the machine is operated with the AquaPrima water filter the “water filter – ON” setting should be activated in the user settings. This results in only every second cycle of the water flow-through metre being registered as an impulse, so that the machine only needs to be descaled half as frequently. It is important that the device does not register whether the water filter has actually been installed; it is the user settings that are decisive. If the machine is operated without a filter it is essential for the water filter setting to be set at “OFF”.

AquaPrima water filter

Operation with and without water filter

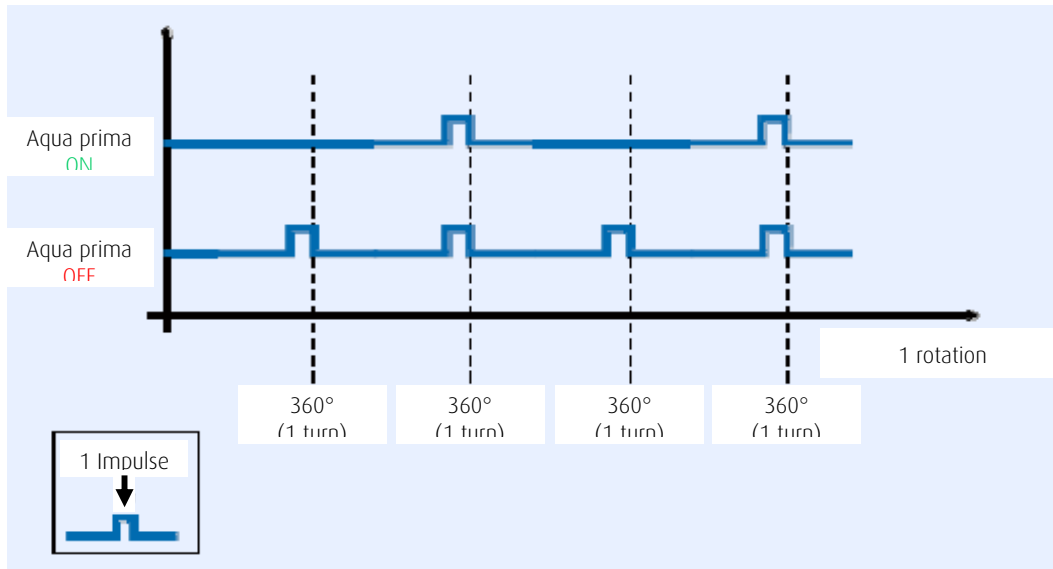

7.3.7 Height and depth adjustable coffee dispenser

Whether you are using a small espresso cup or a large cup for your breakfast-time coffee, any size will fit under the coffee dispenser with a sliding height and depth adjustment. This prevents coffee from splashing onto the machine and guarantees a beautifully creamy crema.

Coffee dispenser – variable settings



- ▶ The height of the coffee dispenser can be adjusted to suit any cup size
- ▶ From below
- ▶ From the top
- ▶ Towards the back and even towards the front

7.3.8 Two separate heating systems

The Küppersbusch fully-automatic built-in coffee machine naturally also supplies hot water for tea or for other hot beverages. Thanks to two separate heating systems, which ensure that hot water and steam are always available, it's easy to make any one of a great variety of coffee specialities.

7.3.9 Cup light-up

LEDs installed in the fully-automatic coffee machine create a great atmosphere. This always shows off the perfect coffee you have made in just the right light.

7.3.10 Accessories

A number of accessories for cleaning and maintenance purposes are supplied with the fully-automatic coffee machine.

Coffee dispenser – variable settings



- ▶ The height of the coffee dispenser can be adjusted to suit any cup size
- ▶ From below
- ▶ From the top
- ▶ Towards the back and even towards the front

The key is used for removing the top sieve when the brewing unit is cleaned. The brush is used to remove residual coffee powder from the machine. The drip safeguard device is inserted into the coffee dispenser when the machine is cleaned. The water filter is used in the water tank to improve the quality of the water. The water hardness strips are used to test the water hardness on the spot. The fat solvent tablets for coffee are for degreasing the brewing unit.

7.4 Care and Maintenance



The machine, the brewing unit and the accessories should be cleaned once a week under running water, without any detergent. Machine components may not be rinsed in a dishwasher, nor may they be dried in the oven or in the microwave oven.

7.4.1 Water tank / bean box

Switch off the machine prior to cleaning the water tank and the bean box. To do so, open up the control panel flap and switch off the main switch located behind it. Pull out the water tank and the bean box towards the front and empty them. Rinse the water tank (and the sieves) and the bean box under running water without any detergent. Dry them well with a cloth. Replace both vessels.

Care and maintenance

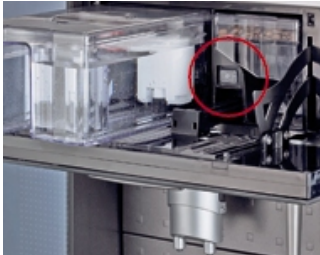
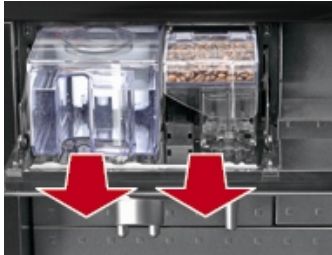
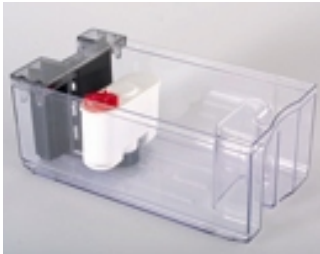
Watertank / Bean container

	
▶ Switch off the appliance	▶ Remove tank / container
	
▶ Clean the tank (incl. sieves)	▶ Empty / clean bean container

7.4.2 Coffee dispenser

Press the coffee dispenser downwards and push the drip safeguard device onto the AromaControl knob in order to clean the coffee dispenser. Remove the drip tray located beneath the coffee dispenser. Open the service flap – the push button is on the left-hand side behind the cover. Press the button on top of the coffee dispenser and pull the dispenser towards the front. Rinse everything under running water without any detergent and then replace the parts.

Care and maintenance

Coffee machine dispenser



- ▶ Press the coffee dispenser towards the back and push the drip safeguard onto the AromaControl device
- ▶ Remove the drip tray



- ▶ Open the service flap (push button behind the cover)



- ▶ Press the button and the top and pull the coffee dispenser towards the front. Rinse it under running water without any detergent.
- ▶ Slide the coffee dispenser onto the holder until it engages.

7.4.3 Nozzle

Pull the nozzle out towards the bottom to clean it and then rinse it under running water without using any detergent.

Care and maintenance

Nozzle



► Pull off the bottom part downwards



► Rinse it under running water without any detergent

7.4.4 Drip tray / Coffee grounds container

To clean the drip tray and the coffee grounds container you will firstly need to pull the drip tray out towards you. Remove the coffee grounds container and the drip tray upwards. Rinse both parts under running water. Do not use any detergent. Dry them thoroughly with a cloth and then replace them.

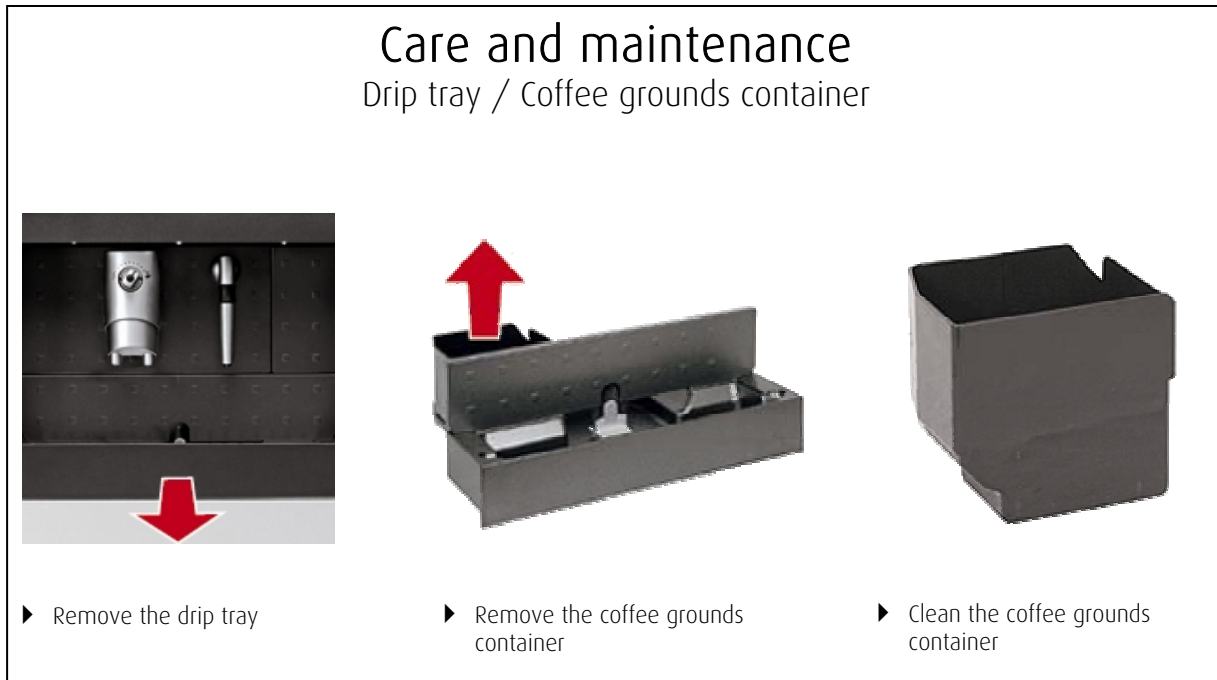



7.4.5 Brewing unit

Push the drip safeguard device onto the AromaControl knob and remove the drip tray located underneath to clean the brewing unit. Open the service flap – the push button is on the left-hand side behind the cover. Push the lever marked PUSH located on the brewing unit and pull the brewing unit towards you. Insert the key enclosed into the top of the brewing unit and turn it carefully anti-clockwise to remove the top sieve. Rinse everything under running water without any detergent.

When subsequently re-assembling the unit install the sieve and the brewing unit in reverse order. Do not press the lever marked PUSH. Close the service flap again.

Care and maintenance

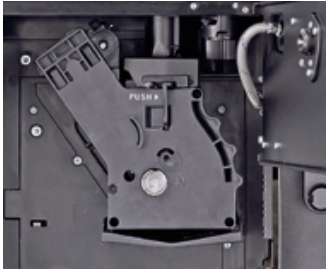
Brewing unit

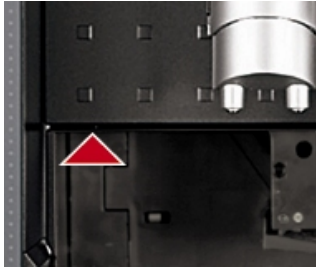

- ▶ Slide the drip safeguard onto the Aromacontrol device
- ▶ Remove the drip tray
- ▶ Open the service flap (push button behind the cover)
- ▶ Press PUSH and pull the brewing unit towards the front
- ▶ Insert the key and remove the top sieve by turning it anti-clockwise – be very careful when using the key
- ▶ Clean / dry everything
- ▶ Replace the sieve and the brewing unit in reverse order
- ▶ Do not press PUSH when assembling the parts
- ▶ Close the brewing unit service flap

7.4.6 Coffee degreaser (cleaning cycle every 14 days or after 250 cups)







The machine should be cleaned every 14 days or after 250 cups of coffee have been made in order to guarantee that it functions perfectly. A cleaning cycle that has commenced cannot be interrupted and will take approx. 7 minutes.

Empty the drip tray prior to commencing with a cleaning cycle and have a spare vessel which holds at least 850 ml ready. The vessel should be observed while the cleaning process is in operation. Put a tablet for degreasing coffee into the top of the brewing unit (refer to section 7.4.5 for instructions on how to remove the brewing unit) and replace the unit. Fill up the water tank and replace it too.

Place the spare vessel under the coffee dispenser and touch button "P". Use the "medium cup" button to select the cleaning cycle mode and confirm with button "P". The procedure will commence and the brewing unit will be cleaned.

Care and maintenance

Cleaning cycle every 14 days or after 250 cups

		
<ul style="list-style-type: none">▶ Put the coffee degreaser into the brewing unit. Insert the brewing unit	<ul style="list-style-type: none">▶ Fill up the water tank and insert it	<ul style="list-style-type: none">▶ Place a vessel under the coffee dispenser (must hold at least 850 ml)
		
<ul style="list-style-type: none">▶ Touch button "P"	<ul style="list-style-type: none">▶ Press the "medium cup" button to activate the cleaning cycle mode	<ul style="list-style-type: none">▶ Confirm with button "P". Procedure takes approx. 7 minutes.





7.4.7 Descaling / automatic limescale indicator

The machine should be descaled every time the clear text display indicates "descale". Never use vinegar for descaling since this may damage the machine. Commercially-available antiliming agents suitable for this type of machine are to be used. If the machine is switched off during the descaling procedure the process will be continued when it is switched on again.

The level of water hardness will determine how frequently the machine needs to be descaled. A test strip has been included with the machine to test the water hardness. Hold this strip under water for one second and take the reading after a minute. The water hardness level shown should be entered in the user settings under "water hardness" (see 7.2.1). The automatic lime scale display will align itself with this setting and will automatically show when it is time to descale.

Care and maintenance / Descaling

Descaling: every time the clear text display indicates "Descaling" or as required

Wasserhärte	120 l	90 l	60 l	30 l
Bereich / Benutzereinstellungen	Härte 1	Härte 2	Härte 3	Härte 4
Wasserhärteprüfstreifen				
entspricht deutscher Härte [°dH]	0-7	7-14	14-21	über 21
entspricht französischer Härte [°fH]	0-12,5	12,5-25	25-37,5	über 37,5
Wasserhärte prüfen: Streifen 1 Sek. unter Wasser halten. Nach 1 Minute ablesen.				

To descale the machine firstly remove the water filter from the water tank. Fill in an antiliming agent and dilute it with at least one litre of water. Then replace the water tank. Place a large vessel under the nozzle and press the "descaler" button for 5 seconds.

Descaling - Preparing



- ▶ Remove the water filter



- ▶ Fill in an antiliming agent and dilute with water (min. 1 litre of liquid)
- ▶ Replace the water tank



- ▶ Place a large vessel under the dispenser



- ▶ Press the button for 5 seconds

Then touch the "medium cup" button and select "YES". The descaling process will commence when button "P" is pressed. The rinsing cycles will now take a minute until the display indicates "rinse machine – press water button". Rinse the water tank thoroughly and fill it up with fresh water.

Descaling



- ▶ Touch the button and select **YES**



- ▶ Press button P – descaling will commence

Rinsing cycles every minute until display shows **Rinse machine Press water button.**



- ▶ Rinse the water tank thoroughly
- ▶ Fill up with fresh water



- ▶ Press  rinsing will commence

The rinsing process will have been completed when the clear text display indicates

"rinsing completed – press water button"



Press the "hot water" button to start the rinsing process. The rinsing process will have been completed when the clear text display indicates "rinsing completed – press water button". Press the "hot water" button again.

Rinse the water tank well and replace the water filter to complete the descaling process. Fill the water tank with fresh water and replace it. Touch the "hot water" button – deaeration will commence. Allow hot water to flow until you have a regular stream of water. Then press the "hot water" button again to complete the process.

Descaling

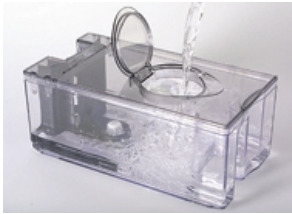

- ▶ Rinse the water tank thoroughly

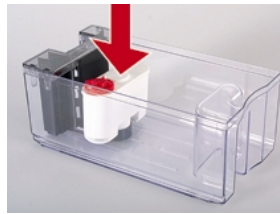

- ▶ Insert the waterfilter (if used)



- ▶ Fill up with fresh water
- ▶ Insert the watertank



- ▶ Press ☁ – deaeration commences.
- ▶ Allow hot water to flow until you have a regular stream of
- ▶ Complete with button

7.5 Assembly / transport

Only move or lift up the machine as shown on the left-hand illustration. To do so, only use the handles on the machine. The machine may not be lifted up as shown on the right-hand illustration. Never use the top control panel as a handle. The brewing group, hot water/steam nozzle and the drip tray may also not be used for lifting up the machine. Failure to observe this will nullify the guarantee in the event of claims for damage.

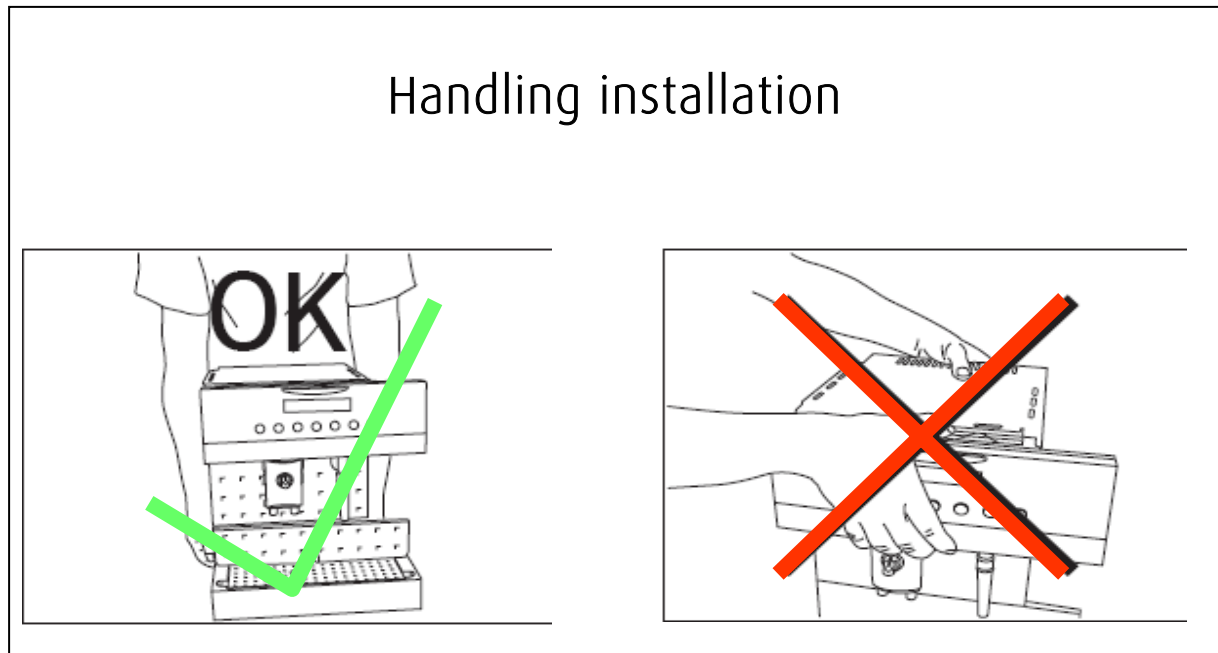

The fully-automatic coffee machine was checked prior to leaving the factory and was tested with coffee. A small amount of residual coffee may remain in the machine despite the fact that it has been thoroughly cleaned. The machine is nevertheless absolutely brand new!

Dimensions for installing the machine in a top cabinet or a tall cabinet

Installation in a wall-hung cupboard

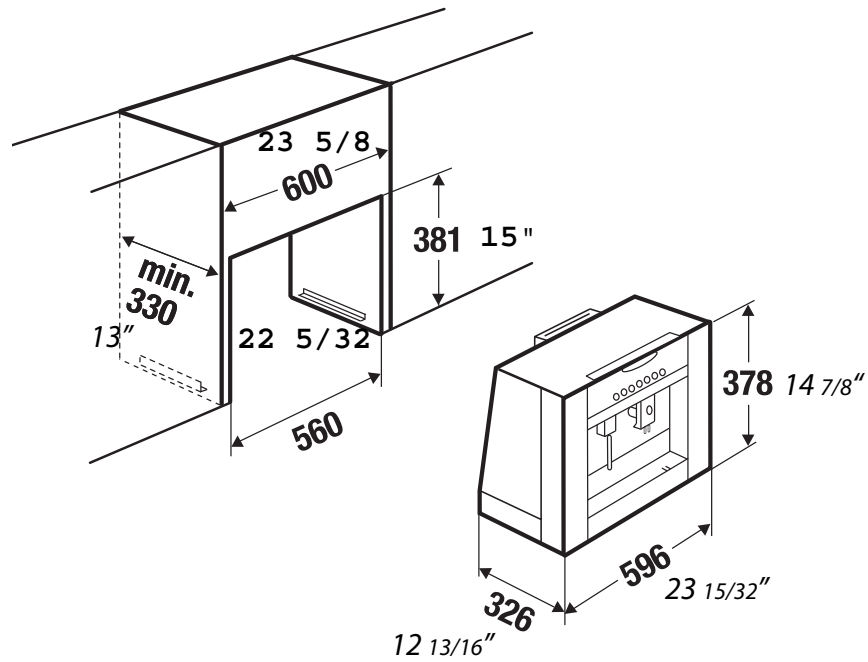

Installation in a tall housing unit

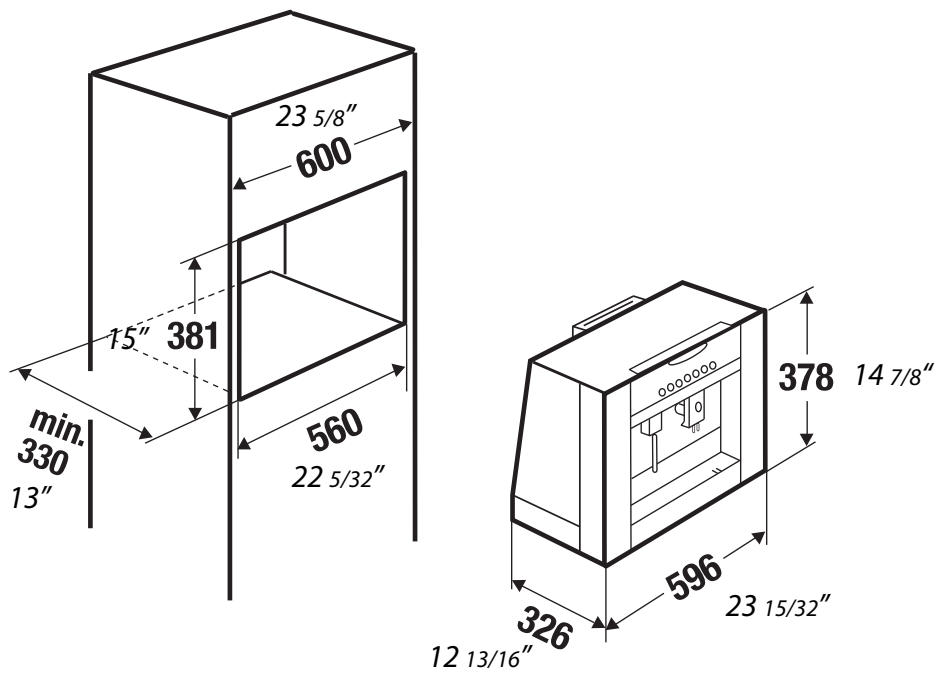

7.6 Appendix

7.6.1 Carrying out minor repairs yourself

Carrying out minor repairs yourself

- ▶ Machine does not switch on
- ▶ Coffee is not hot enough
- ▶ No hot water or steam
- ▶ Machine takes too long to heat up
- ▶ The brewing group cannot be removed for cleaning purposes
- ▶ Too little or no coffee dispensed
- ▶ Lighting defect

Machine does not switch on	<ul style="list-style-type: none">▶ Switch on the main switch▶ Check the power connection▶ Check the fuses of the house wiring system
Coffee is not hot enough	<ul style="list-style-type: none">▶ Pre-heat cups with hot water▶ Adjust the brewing temperature
No hot water or steam	<ul style="list-style-type: none">▶ Switch off the machine! Clean the nozzle
Machine takes a long time to heat up	<ul style="list-style-type: none">▶ Descale the machine
The brewing group cannot be removed for cleaning purposes	<ul style="list-style-type: none">▶ Close the service flap▶ Switch on the machine (brewing group will be initialised)
Too little or no coffee dispensed	<ul style="list-style-type: none">▶ Check the grinding setting and the AromaControl
Lighting defect	<ul style="list-style-type: none">▶ Switch on the main switch▶ Adjust the lighting

7.6.2 Technical data

Built-in automatic coffee machine EKV 6600.0 M



- ▶ Central controls
- ▶ Red clear text display
- ▶ Push and pullflap
- ▶ Front watertank, 1.7 litres
- ▶ Front bean box for 300 g beans
- ▶ Niche height 38cm
- ▶ Can be installed in a tall housing unit or a wall-hung cupboard
- ▶ Weight: approx. 13 kg approx 28lbs
- ▶ Dimensions:

Technical data

Electrical connection	115V 60Hz, 15A, 1250W
Weight	approx. 13 kg approx 28lbs
Water tank (water filter)	1.8 l (1.7 l) – removable
Bean container capacity	300 g
Grounds container capacity	15 pcs. volumeter
Drip tray capacity	12 pcs.
Pumping capacity	15 bar
Grinder	Ceramic disk grinder
Height-adjustable dispenser	80 – 105 mm, back 155 mm
Lighting	3LED

7.6.3 Short lesson on coffee – coffee specialities

Affogato

Pour hot espresso over a scoop of vanilla ice cream. This is ideal for a dainty little dessert after a substantial dinner or as a light Italian refreshment on a hot summer afternoon or evening.

Caffè latte

Caffè latte is made up of two or three espressos and an espresso quantity of hot milk with which the caffè is topped. In rare cases a little milk foam will be added. In France this beverage is called "café au lait" and in Germany it is known as "Milchkaffee (milk coffee)".

Caffè lungo

During the brewing process an espresso cup is filled up right to the top to result in a caffè lungo.

Caffè macchiato

If you "dirty" an espresso with a small topping of milk foam, the result will be a caffè macchiato (*Ital. macchiato = dirty*).

Cappuccino

Next to espresso itself, cappuccino is probably the most renowned type of coffee. Cappuccino comprises an espresso, a topping of two to three centimetres of thick milk foam and a little hot milk (approx. a one-third proportion each). Just like for espresso the rule here is: add sugar according to taste! The temperature is also important: hot but not too hot!

Coretto

Coretto is "laced" espresso – laced with brandy, liqueur or best of all, grappa!

Doppio

Doppio is simply a double espresso, that is, double the quantity of everything: double the quantity of water, double the amount of espresso powder and possibly double the amount of sugar too. This should all be served in a cup – but a spoonful is also quite sufficient for "double" enjoyment!

Doppio Ristretto

When you make a doppio and reduce the water quantity for the two espressos to ristretto format, you will have a doppio ristretto. Farewell fatigue ... !

Espresso

Espresso, simply called "caffè" by Italians, is the basis for all of the other Italian coffee specialities. The "black & strong" beverage fills up around two-thirds of an espresso cup, 40 ml in terms of figures. What is typical for a good espresso is the crema, which should be hazelnut brown in colour, marbled with just a touch of red on the top. The crema is the crown on an espresso. However, it can only be produced if the pump has a certain power output to create pressure in the machine; this is why cheap machines are seldom able to produce crema. Espresso should have a full flavour and taste slightly bitter and aromatic. Espresso will need to be stored at fairly cool temperatures if this is to be achieved. Using freshly-ground beans is best of all. It is also important to portion the coffee just right and ground espresso must be of a good quality. Enjoyment will be enhanced even more if a glass of fresh water is served with an espresso. And a little biscuit is perfect too!

Espresso sorbetto

Espresso sorbetto is a refreshing and at the same time low-calory beverage, suitable as a dessert or simply as an in-between! Freeze 350 ml espresso and stir the espresso ice cubes in a mixer with four sugar cubes and 500 ml low-fat milk. Serve well-chilled in suitable glasses.

Iced Espresso

Enjoying a glass of ice-cold espresso or cappuccino on hot summer afternoons or balmy nights is a unique experience. Experts also cover the glass with a damp serviette before serving iced espresso.

Granita di caffè

Granita di caffè, comprising a layer of whipped cream as a base covered with frozen crushed espresso and then topped with another layer of whipped cream. Sounds delicious – and tastes delicious too!!!

Latte macchiato

"Latte macchiato" could mean "breakfast" in Italian, since for Italians it is the "early morning" version of Italian coffee enjoyment. Hot foamy milk is put into a tall glass with a little hot milk. Espresso or ristretto is then slowly and very carefully poured on top so that the milk foam takes on a marmored appearance (also a real pleasure to look at).

Ristretto

Ristretto is small, black, strong and effective – a concentrated espresso (two-thirds of the "normal" quantity of water).

Küppersbusch

THE HEART OF A GOOD KITCHEN

Küppersbusch USA

1883 Massaro Blvd
Tampa, FL 33566
Tel 1-800-459-0844
Fax 1-800-288-8604

(*Gebühren für eine Verbindung über die Deutsche Telekom 14ct/min.)